

SOME GaAsFET PREAMPLIFIERS

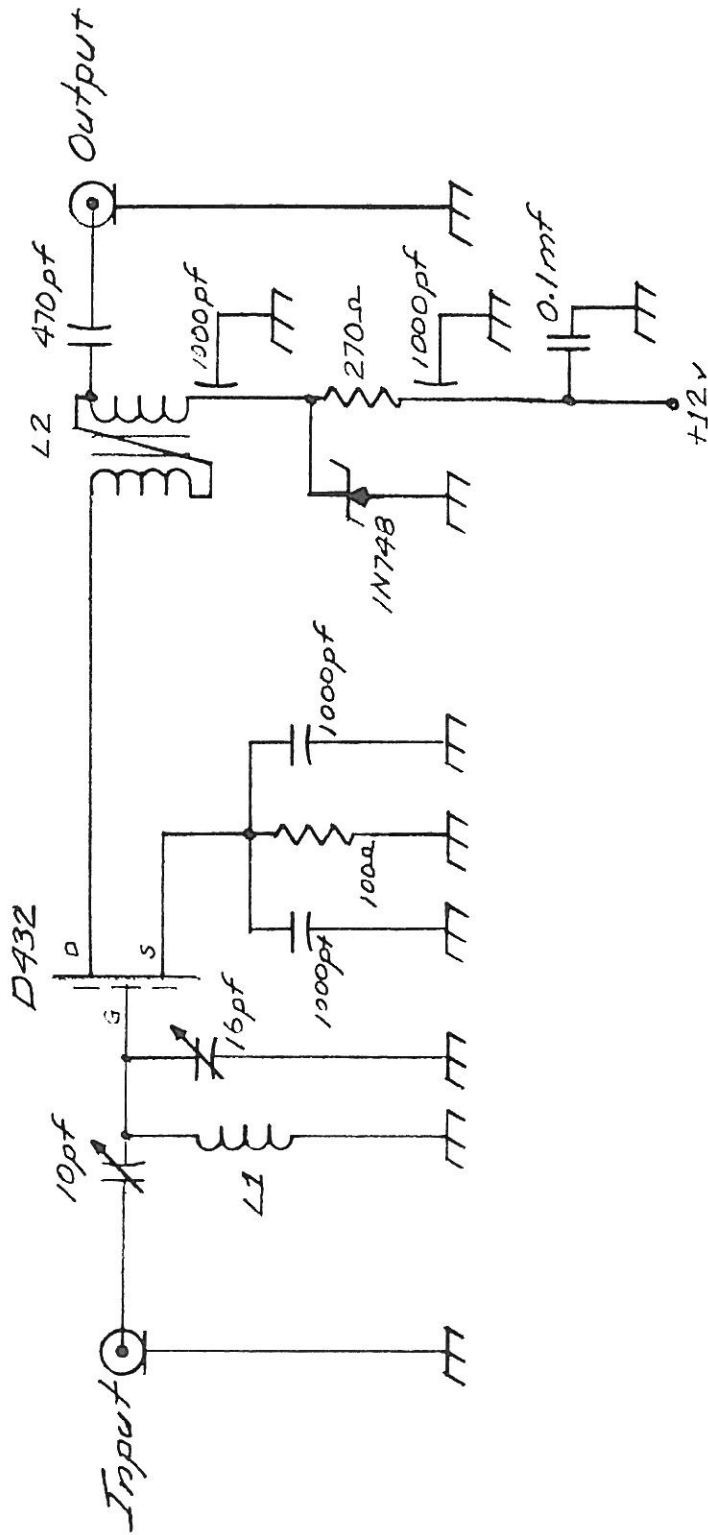

varian, EIMAC division
301 industrial way
san carlos, california 94070

The three GaAsFET preamplifiers described in this EME note were built by W6PO and all are electrically the same. The schematic included in this note can be used for 144, 220 and 432 MHz. The die cast enclosure used on all three preamplifiers was a BUD CU123. A COMPAC DC 4001 enclosure can also be used. The most important thing to remember is to use absolutely the best components available for the gate circuit. The unloaded "Q" of the gate circuit should be very high to insure a low noise figure. (As an example, with a coil and capacitor circuit in the gate circuit of the 432 MHz preamplifier, the noise figure would not go below 0.7 dB. With the higher "Q" stripline, the noise figure went down to 0.47 dB. Perhaps stripline techniques on 144 and 220 MHz would improve these amplifiers as well.) The noise figure will be 0.5 dB, or lower, with all three preamplifiers. The GaAsFET wants to look into a 100 to 200 ohm load. The 4:1 transformer does the job very well by making a 50 ohm second stage look like 200 ohms. A tuned circuit could be used with more complexity, but the gain of the stage with the transformer will be 18-20 dB on 432 MHz and 20-24 dB on 144 and 220 MHz. No input to output circuit shielding was necessary when using the 4:1 transformer circuit. This transformer idea was suggested by K6OJM and W6YFK. All three preamplifiers were stable in or out of the box. Stability was checked with a spectrum analyzer, noise figure meter and on the air checks.



144 MHz

L1 6 turns #14 wire
1/4" (0.64 cm) I.D.
1/2" (1.27 cm) long

L2 12 turns of twisted
pair of #24 enameled
wire on Micrometals
T37-0 toroid connected
as 4:1 transformer

220 MHz

4 turns #14 wire
1/4" (0.64 cm) I.D.
1/2" (1.27 cm) long

14 turns of twisted
pair of #24 enameled
wire on Micrometals
T30-0 toroid connected
as 4:1 transformer

432 MHz

Copper strap 2 1/4" (5.72 cm)
long by 0.6" (1.52 cm) wide
spaced 0.171" (0.43 cm) above
ground plane

5 turns of twisted pair #30
enameled wire on 1/4" (0.64 cm)
diameter Q1 ferrite toroid
connected as 4:1 transformer

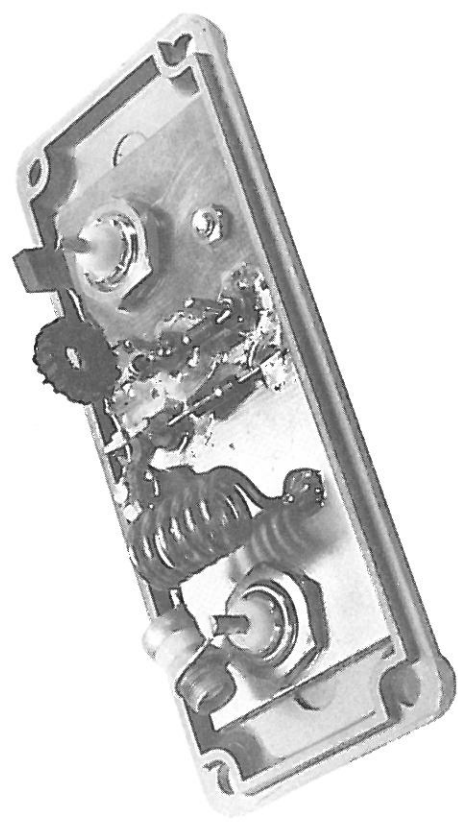
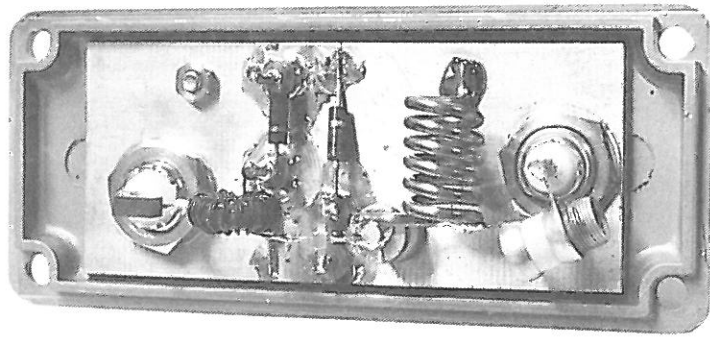
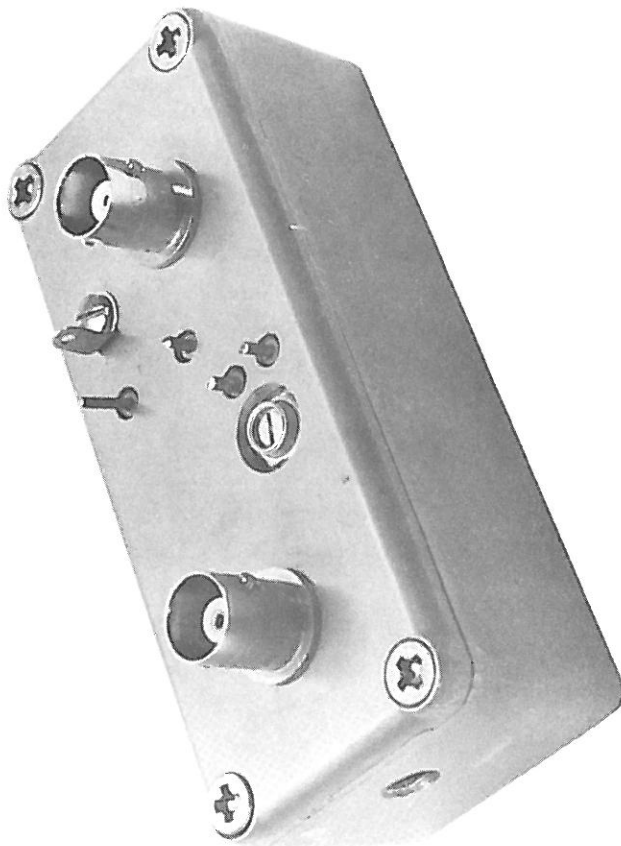

LAYOUT OF THE 144 MHZ AND 220 MHZ PREAMPLIFIER

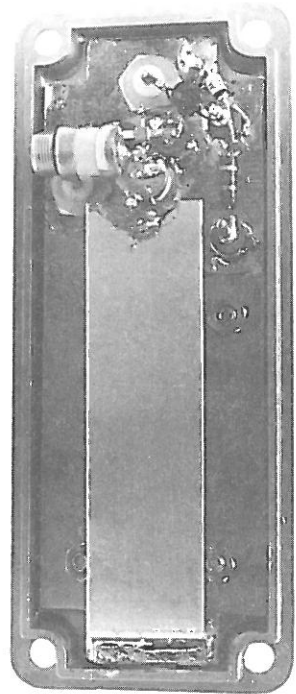
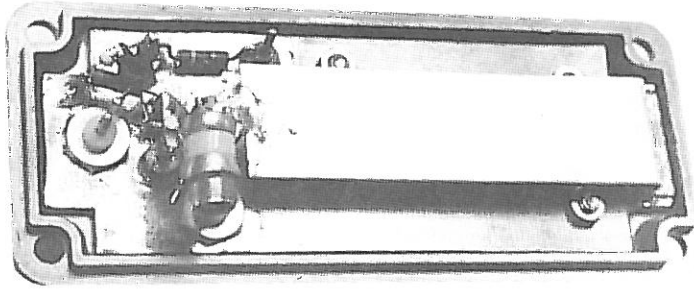
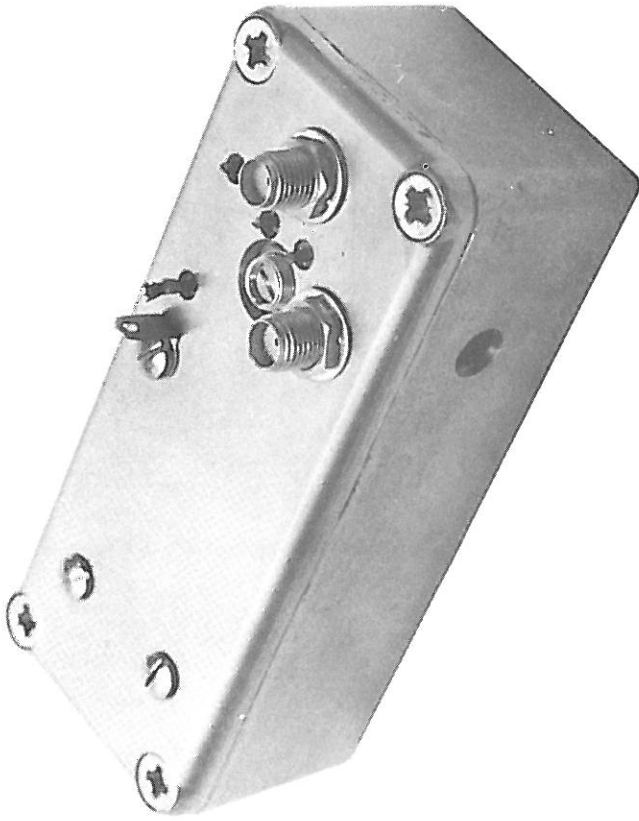

LAYOUT OF THE 432 MHZ PREAMPLIFIER

