

Anode deel DL9EBL cavity 1296 MHz

Onderplaat DL9EBL cavity 1296 MHz

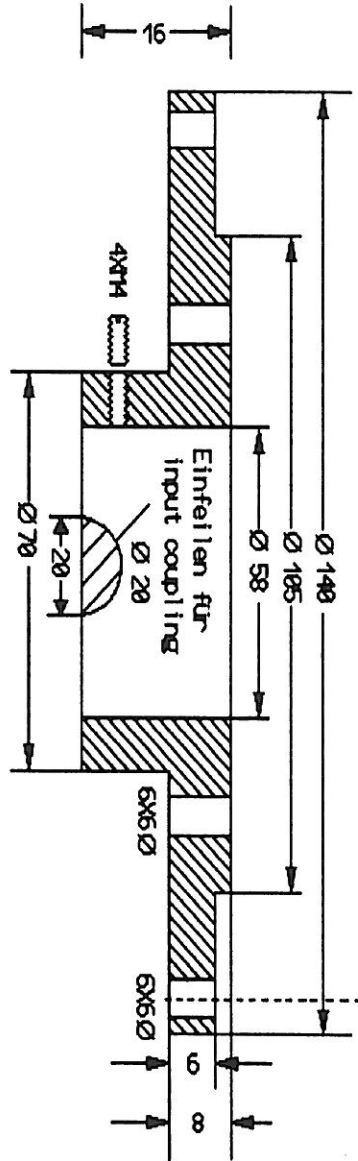

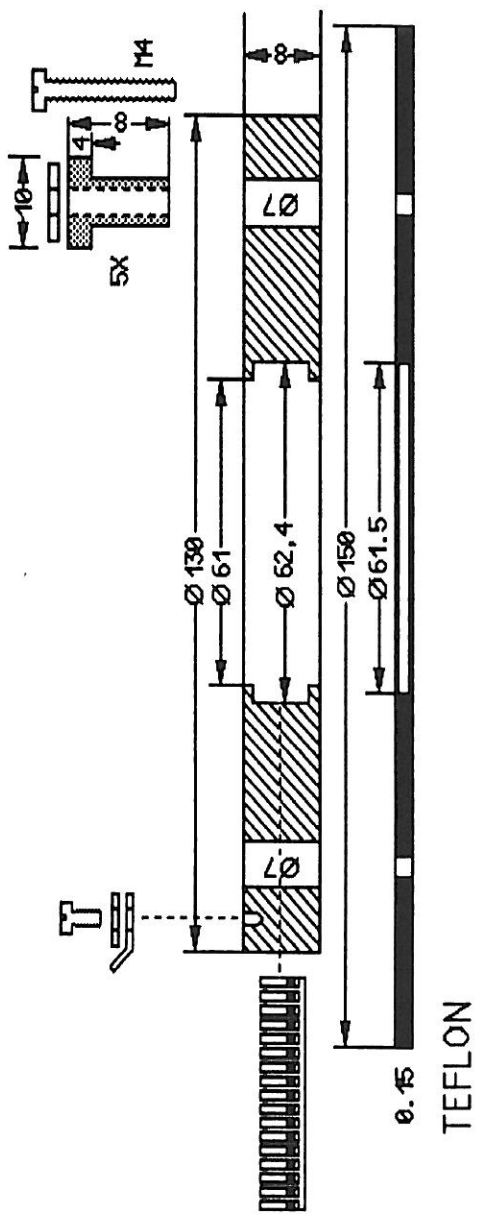

Anode plaat en toebehoor

bovendeel DL9EBL cavity 1296 MHz

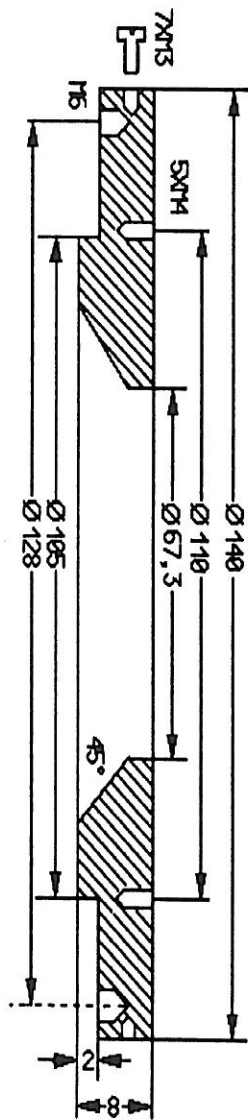

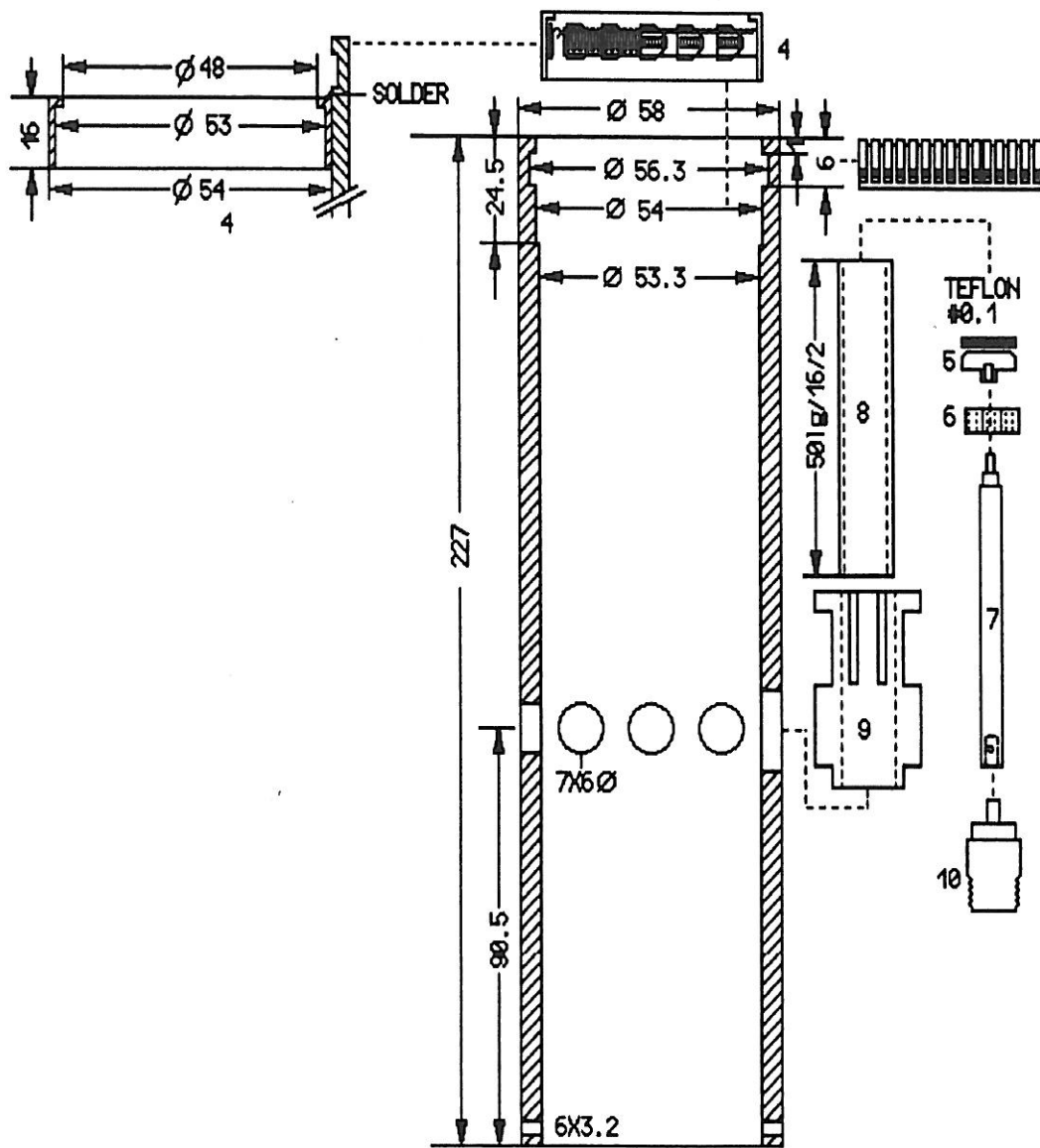

Screen en toebehoor
DL9EBL cavity 1296 MHz

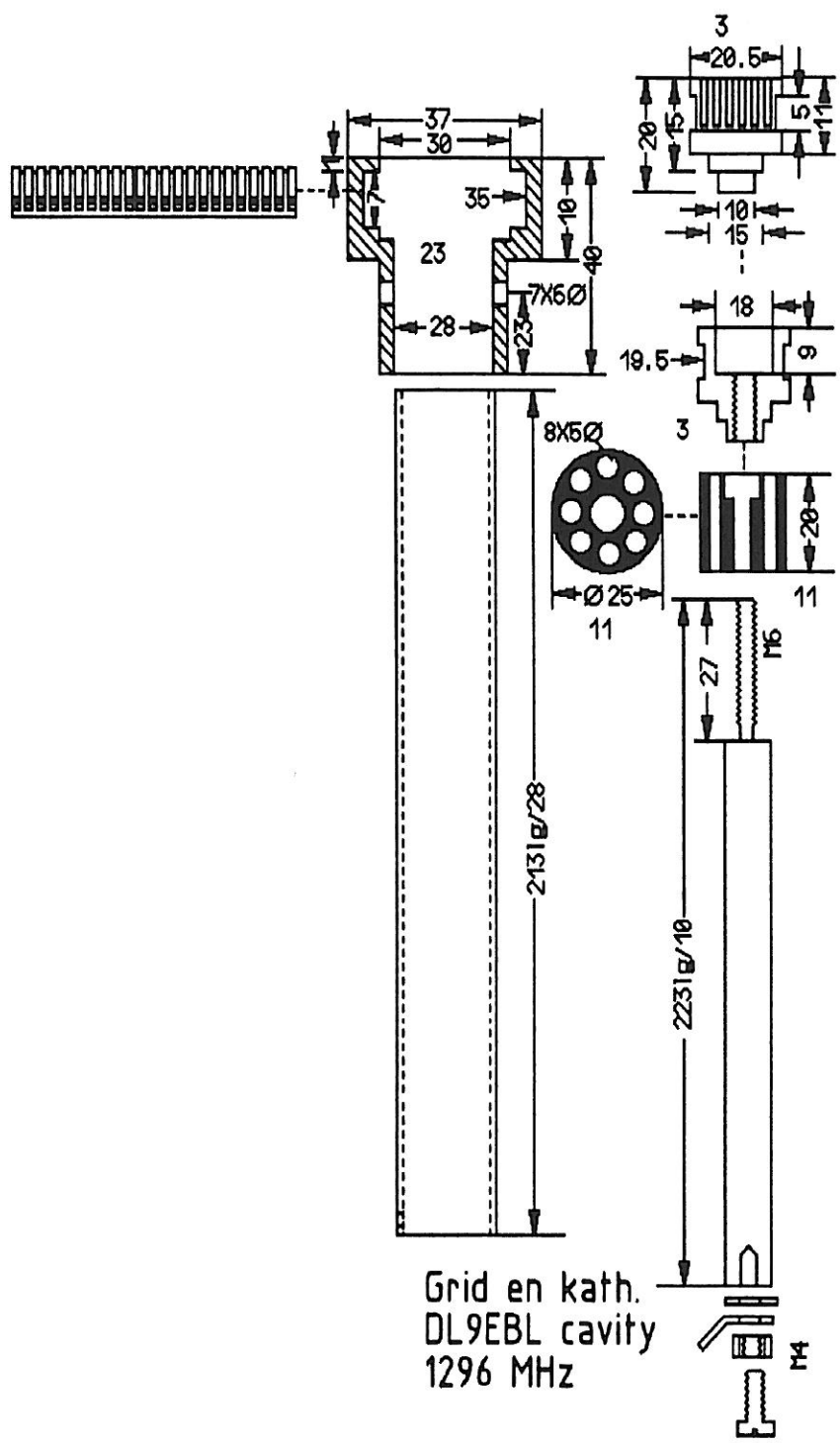

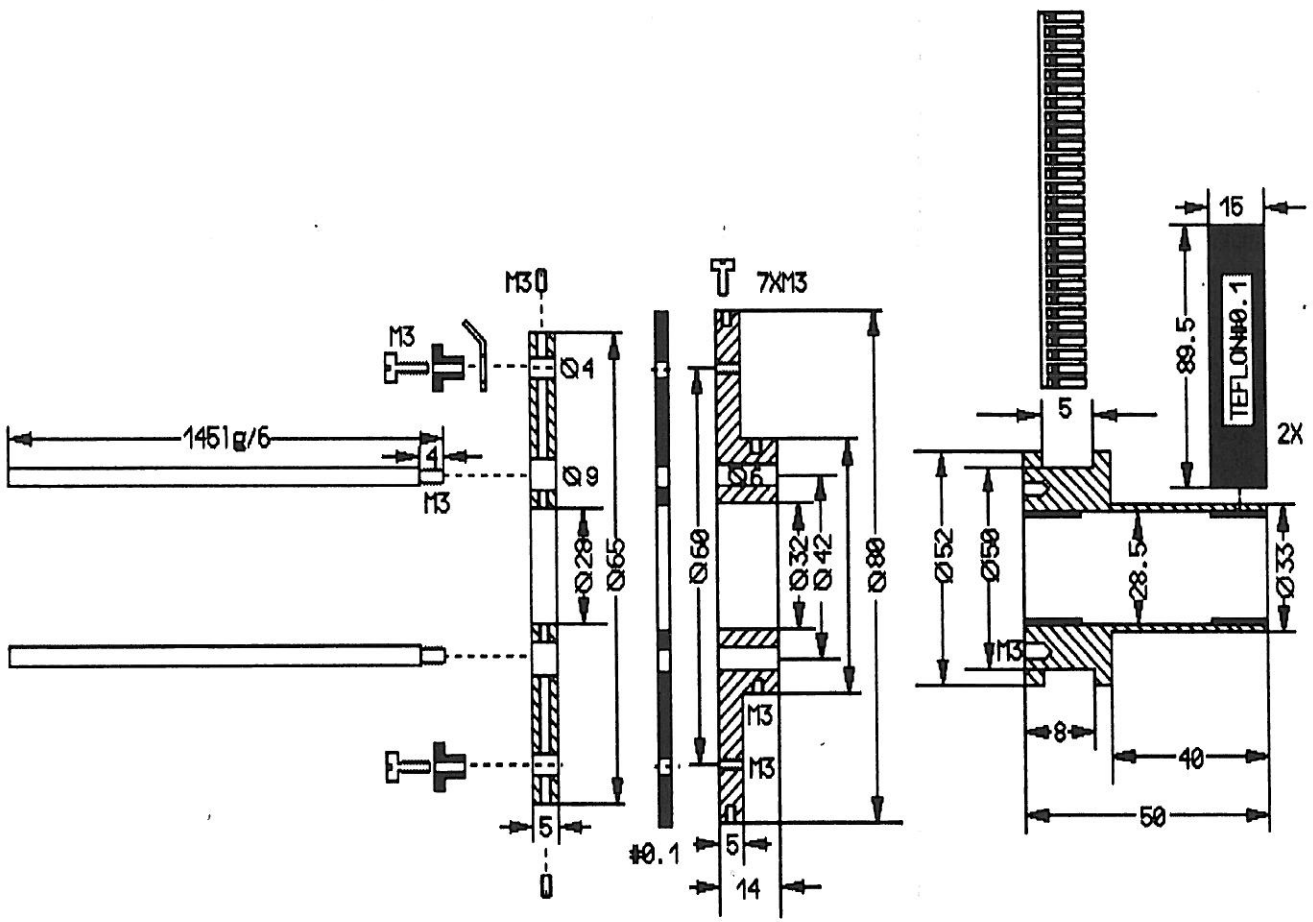

Kathode deel DL9EBL cavity 1296 MHz

Diverse onderdelen DL9EBL
cavity 1296 MHz

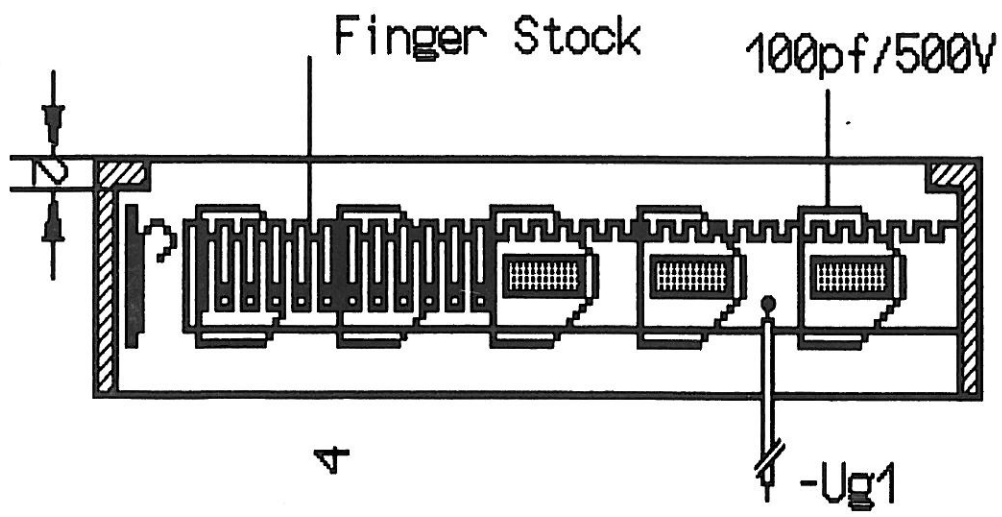
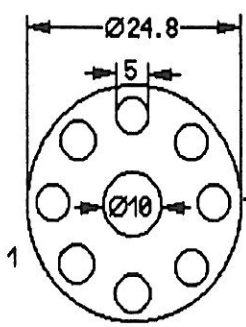
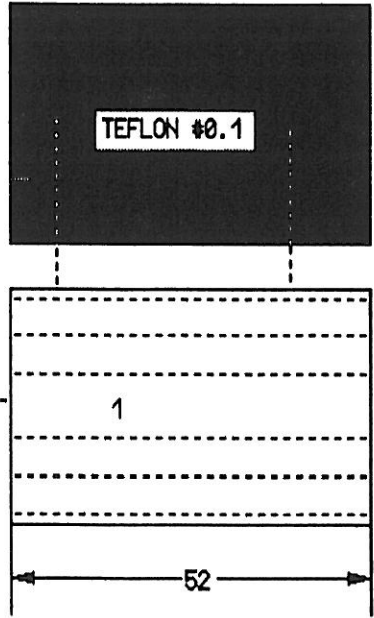
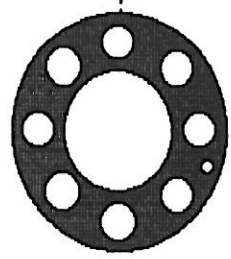
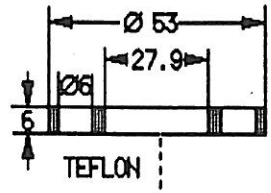

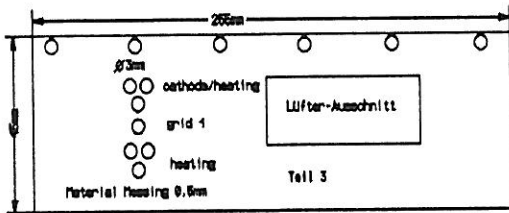
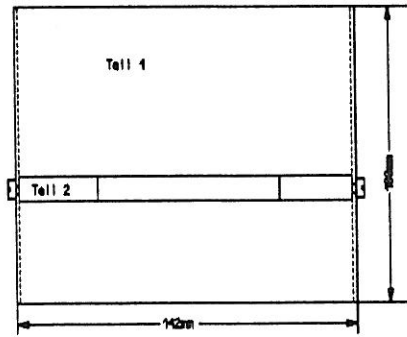
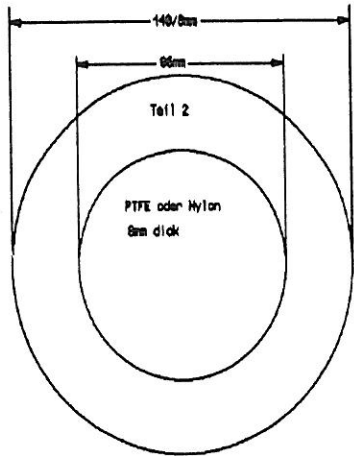
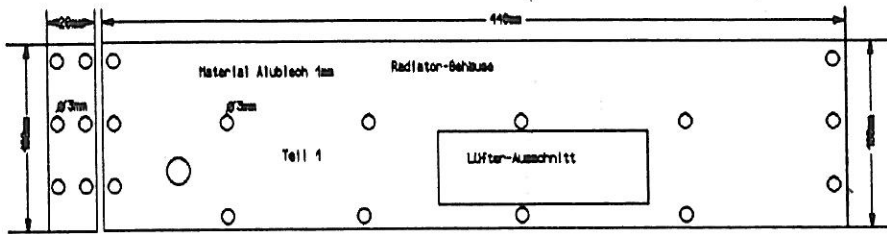

Material Messing 0,6mm
Maße je nach Lüfter Typ

Lüfter-Flansch

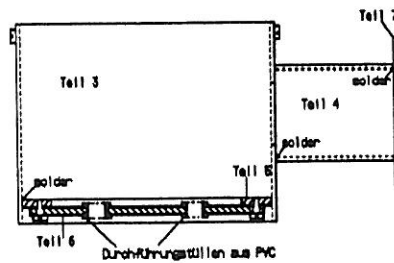
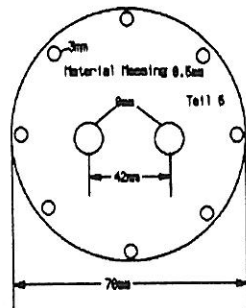
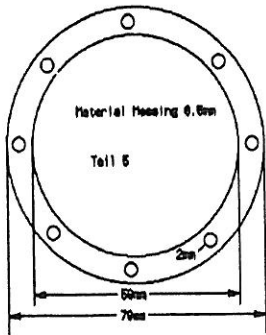
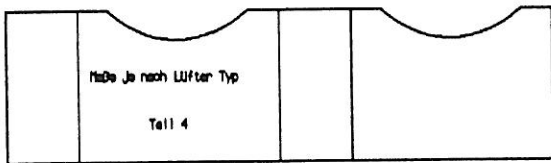
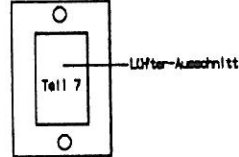

YL 1050

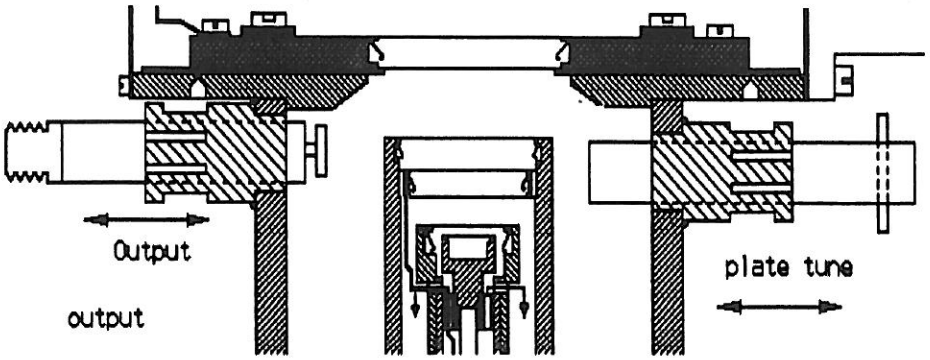

400 W

YL 1050

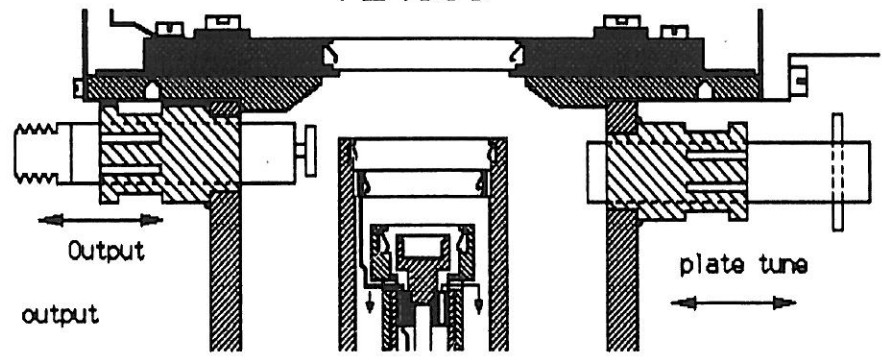

1000 W

YL 1050

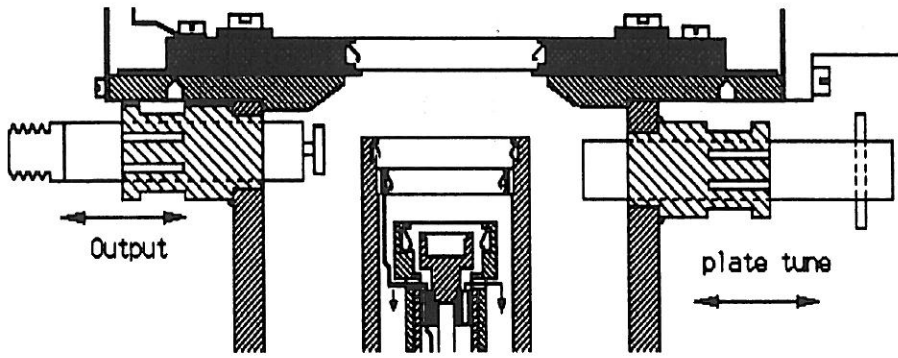

800 W

